



Insertion flowmeter or batch controller with paddle wheel and flow transmitter or remote batch controller

- Up to PN 10, size of measuring tube: DN 06...DN 400
- Display for indication of flow rate and volume with two totalizers or dosing
- Automatic calibration using Teach-In
- Inputs (with batch controller) and all outputs can be checked without the need for actual flow
- Total and day counters for batch quantity and number of dosing, volume or mass counter indicator (with batch controller)

Product variants described in the data sheet may differ from the product presentation and description.

Can be combined with



Type 8611 ▶
eCONTROL - Universal controller



Type 8619 ▶
multiCELL - Multi-channel and multi-function transmitter/controller



Type 8802 ▶
ELEMENT continuous control valve systems - overview



Type 8644 ▶
Remote Process Actuation Control System AirLINE

Type description

The Type 8025 flowmeter or batch controller is specially designed for use in neutral, slightly aggressive, solid-free liquids.

Type **8025 flowmeter** is offered in different versions.

- The compact flowmeter with paddle wheel sensor is available in two versions:
 - standard output signal or
 - battery powered indicator/totalizer version without output.
- The remote transmitter is available in two versions:
 - Universal transmitter for control cabinet or wall mounting, which can be connected to other flow sensors; sensors with open collector output, reed relay output, TTL, CMOS or coil can be operated by this transmitter.
 - transmitter, for control cabinet or wall mounting: standard signal input for combination with the Bürkert Type 8020/8030/SE30+S077 flowmeters “Low Power” version.

Type **8025 batch controller** is also available in various versions:

- The compact batch controller with paddle wheel sensor
- The remote batch controller for control cabinet or wall mounting for coupling to the Bürkert Type 8020/8030/8031/8041/SE30+S077 flowmeters or to other flow sensors; sensors with open collector output, reed relay output, TTL, CMOS or coil can be operated by this batch controller.

Table of contents

1. General Technical Data	4
1.1. About the device.....	4
1.2. Insertion flowmeter or compact batch controller	4
General data	4
Insertion flowmeter	6
Insertion compact batch controller.....	8
1.3. Flow transmitter (Universal/for “Low Power” flowmeters) or remote batch controller.....	10
General data	10
Universal flow transmitter	11
Flow transmitter for “Low Power” flowmeters	13
Remote batch controller	14
2. Product versions	16
2.1. Insertion flowmeter	16
2.2. Insertion compact batch controller.....	16
2.3. Universal flow transmitter	17
2.4. Flow transmitter for “Low Power” flowmeters	17
2.5. Remote batch controller	17
3. Approvals	18
3.1. Certification UL.....	18
3.2. Pressure Equipment Directive.....	18
Device used on a pipe	18
4. Materials	18
4.1. Chemical Resistance Chart – Bürkert resistApp.....	18
4.2. Material specifications	19
Insertion flowmeter or compact batch controller.....	19
Flow transmitter (Universal/for “Low Power” flowmeters) or batch controller - panel version	19
Flow transmitter (Universal/for “Low Power” flowmeters) or batch controller - wall-mounted version	20
5. Dimensions	20
5.1. Insertion flowmeter or compact batch controller.....	20
5.2. Device installed in a S020 fitting.....	21
5.3. Flow transmitter or remote batch controller	21
Universal flow transmitter as panel version	21
Universal flow transmitter as wall-mounted version	22
Flow transmitter for “Low Power” flowmeters as panel version	22
Flow transmitter for “Low Power” flowmeters as wall-mounted version	23
Batch controller as panel version	23
Batch controller as wall-mounted version	24
6. Performance specifications	24
6.1. Pressure temperature diagram.....	24
7. Product installation	25
7.1. Installation notes.....	25
8. Product operation	26
8.1. Measuring principle	26
8.2. Functional overview	26

Display and operating keys.....	26
Flowmeter with a standard output signal and flow transmitter (Universal/for “Low Power” flowmeters).....	28
Insertion flowmeter as battery powered indicator/totalizer	29
Batch controller - compact and remote version	30
8.3. Function modes	31
Insertion flowmeter with a standard output signal.....	31
Batch controller - compact and remote versions	31
9. Product design and assembly	32
9.1. Product assembly	32
Insertion flowmeter or batch controller - compact version.....	32
Flow transmitter or batch controller - remote version	32
10. Networking and combination with other Bürkert products	33
10.1. Networking and combination of the compact device.....	33
Insertion flowmeter with a standard output signal.....	33
Batch controller	33
10.2. Combination of the compact device with available S020 fittings DN.....	33
10.3. Combination of the remote version	34
11. Ordering information	35
11.1. Bürkert eShop – Easy ordering and quick delivery.....	35
11.2. Recommendation regarding product selection	35
Insertion compact flowmeter or compact batch controller	35
Universal flow transmitter	35
Flow transmitter for “Low Power” flowmeters	35
Remote batch controller	36
11.3. Bürkert product filter.....	36
11.4. Ordering chart.....	36
Insertion flowmeter	36
Compact batch controller	37
Universal transmitter	37
Flow transmitter for “Low Power” flowmeters	38
Remote batch controller	38
11.5. Ordering chart accessories.....	39
Accessories for compact device	39
Accessories for remote device	39

DTS 1000011079 EN Version: AC Status: RL (released | freigegeben | valide) printed: 25.02.2022

1. General Technical Data

1.1. About the device

The device Type 8025 is available as a flowmeter or a batch controller in compact or remote version.



Furthermore, the compact flowmeter is available either as a measuring device with a standard output signal or as a battery powered indicator/totalizer.

In addition, the remote flowmeter (called flow transmitter) as well as the batch controller are available in two versions: a Universal version or a version for Bürkert "Low Power" flowmeters, both available in wall-mounted and panel-mounted versions.

1.2. Insertion flowmeter or compact batch controller

General data

The following data are valid for both the flowmeter and the batch controller.

Product properties

Material

Please make sure the device materials are compatible with the fluid you are using.

Detailed information can be found in chapter "4.1. Chemical Resistance Chart – Bürkert resistApp" on page 18.

Non wetted parts

Housing, cover	PC
Lid	PC
Front panel foil	Polyester
Nut	PC
Seal	NBR
Screws	Stainless steel
Female cable plug/male fixed plug	<ul style="list-style-type: none"> • Body, contact holder and cable gland in PA • Cable gland seal and flat seal in NBR
Cable glands	PA

Wetted parts

Seal	FKM standard (EPDM included, but not mounted)
Axis and bearings	Ceramics (Al ₂ O ₃)
Sensor holder, paddle wheel	PVDF

Dimensions Detailed information can be found in chapter "4. Materials" on page 18.

Measuring principle Paddle wheel

Compatibility Any pipe from DN 20¹⁾...DN 400 which is fitted with Bürkert S020 Insertion fitting. For the selection of the nominal diameter of the Insertion fittings, see **data sheet Type S020** ►.

Display 15 × 60 mm, 8-digit LCD, alphanumeric, 15 segments, 9 mm high

Pipe diameter DN 20¹⁾...DN 400

Measuring range

- Flow rate: 0.5...75000 l/min
- Flow velocity: 0.3...10 m/s

Performance data

Measurement deviation

- Teach-In: ± 1 % of the measured value²⁾ at Teach-In flow rate value
- Standard K-factor: ± 2.5 % of the measured value¹⁾

Linearity ± 0.5 % of full scale²⁾

Repeatability ± 0.4 % of the measured value²⁾

Electrical data

Power source (not supplied)	Limited power source according to UL/EN 60950-1 standards or limited energy circuit according to UL/EN 61010-1 §9.4
DC reverse polarity protection	Yes
Overvoltage protection	Yes
Voltage supply cable	<ul style="list-style-type: none"> Cable with maximum operating temperature greater than 80 °C (90 °C for UL-Recognized version) Max. 50 m length

Medium data

Fluid temperature	With fitting Type S020 in: <ul style="list-style-type: none"> PVC: 0...+50 °C (+32...+122 °F) PP: 0...+80 °C (+32...+176 °F) PVDF, stainless steel or brass: -15...+80 °C (+5...+176 °F) (up to +100 °C (212 °F) for flowmeter with batteries) See data sheet Type S020 ▶ for more information.
Fluid pressure	Max. PN 10 See data sheet Type S020 ▶ for more information.
Viscosity	Max. 300 cSt
Rate of solid particles	Max. 1 %
Maximum particle size	0.5 mm

Process/Port connection & communication

Port connection	G 2" for use with Type S020 Insertion fitting See data sheet Type S020 ▶ for more information.
-----------------	--

Approvals and certificates

Standards

Degree of protection ^{3.)} according to IEC/EN 60529	IP65 under the following conditions: device wired, cover and lid screwed tight and cable plug or glands mounted and tightened or with blind plug if not used
---	--

Directives

CE directives	The applied standards, which verify conformity with the EU Directives, can be found on the EU Type Examination Certificate and/or the EU Declaration of conformity (if applicable).
Pressure Equipment Directive	Complying with Article 4, Paragraph 1 of 2014/68/EU directive Detailed information on the pressure equipment directive can be found in chapter " 3.2. Pressure Equipment Directive " on page 18.
Certification	UL-Recognized for US and Canada

Environment and installation

Relative air humidity	≤ 80 %, without condensation
Height above sea level	Max. 2000 m
Operating conditions	Continuous
Equipment mobility	Fixed
Application range	Indoor and outdoor (protect the device against electromagnetic interference, ultraviolet rays and, when installed outdoors, against the effects of climatic conditions)
Installation category	Category I according to UL/EN 61010-1
Pollution degree	Degree 2 according to UL/EN 61010-1

1.) Limited for some fitting process connections

2.) Under reference conditions i.e. measuring fluid = water, ambient and water temperature = 20 °C (68 °F), while maintaining the minimum inlet and outlet distances and the appropriate internal diameters of the pipes.

3.) Not evaluated by UL

Insertion flowmeter

Note:

If the device is mounted in a humid environment or outside, then the maximum voltage allowed is **35 V DC** instead of 36 V DC.

Performance data

4...20 mA output uncertainty ± 1 % of range

Electrical data

Operating voltage (V+)	<p>Measuring device with a standard output signal</p> <ul style="list-style-type: none"> 12...36 V DC ± 10 %, filtered and regulated <p>Connection to main supply: permanent (through external SELV (Safety Extra Low Voltage) and LPS (Limited Power Source) power supply</p> <ul style="list-style-type: none"> 115/230 V AC, 50/60 Hz <p>Voltage supply available inside the device:</p> <ul style="list-style-type: none"> – supplied voltage: 27 V DC regulated – maximum current: 125 mA – integrated protection: 125 mA time delay fuse
Current consumption	<p>Battery powered indicator/totalizer</p> <ul style="list-style-type: none"> 4 x 1.5 V DC non-rechargeable alkaline AA batteries, lifetime 4 years at 20 °C (68 °F) <p>12...36 V DC powered measuring device with a standard output signal, with sensor and without pulse output consumption</p> <ul style="list-style-type: none"> With relays: ≤ 70 mA Without relay: ≤ 25 mA
Power consumption	115/230 V AC powered measuring device: 3 VA
Outputs	<p>Measuring device with a standard output signal</p> <ul style="list-style-type: none"> Pulse (potential free transistor): <ul style="list-style-type: none"> – polarized, NPN or PNP (wiring dependant) – function: pulse output, adjustable pulse value – 0...400 Hz – 5...36 V DC, 100 mA, voltage drop at 100 mA: 2.5 V DC – duty cycle (pulse duration/period): 0.5 – galvanic insulation and protected against overvoltage, polarity reversals and short circuit Relay: <ul style="list-style-type: none"> – 2 relays, hysteresis, adjustable thresholds, normally open – non UL recognized device: 230 V AC/3 A or 40 V DC/3 A (resistive load) – UL recognized device: 30 V AC/42 V_{peak}/3 A or 60 V DC/1 A Current: <ul style="list-style-type: none"> – 4...20 mA (3-wire with relays; 2-wire without relay) – sourcing or sinking (wiring dependant) – max. loop impedance: 900 Ω at 30 V DC, 600 Ω at 24 V DC, 50 Ω at 12 V DC, 800 Ω with a 115/230 V AC voltage supply – response time (10...90 %) for the measured value: 6 s (default)) <p>Battery powered indicator/totalizer</p> <ul style="list-style-type: none"> Without output

Voltage supply cable	<p>Measuring device with a standard output signal</p> <ul style="list-style-type: none"> External diameter (cable): <ul style="list-style-type: none"> 5...8 mm (with cable plug) 6...12 mm (1 cable per cable gland) or 3...5 mm when using a multi-way seal (2 cables per cable gland) Cross section of wires: <ul style="list-style-type: none"> 0.25...1.5 mm² (with cable plug) 0.75 mm² (with cable gland) Cross section the local ground wire: max. 0.75 mm² <p>Battery powered indicator/totalizer</p> <ul style="list-style-type: none"> None
Process/Port connection & communication	
Electrical connection	<ul style="list-style-type: none"> Version 12...36 V DC: cable plug or cable glands M20 × 1.5 Version with batteries: None
Environment and installation	
Ambient temperature	<p>Operation and storage:</p> <ul style="list-style-type: none"> Version 12...36 V DC: -10...+60 °C (+5...+140 °F) Version 115/230 V AC: -10...+50 °C (+5...+122 °F) Version with batteries: -10...+55 °C (+5...+131 °F)

Insertion compact batch controller

Note:

If the device is mounted in a humid environment or outside, then the maximum voltage allowed is **35 V DC** instead of 36 V DC.

Electrical data	
Operating voltage (V+)	<ul style="list-style-type: none"> 12...36 V DC, max tolerance: -5 % or +10 % at 12 V DC, ±10 % at 36 V DC, filtered and regulated Connection to main supply: permanent (through external SELV (Safety Extra Low Voltage) and LPS (Limited Power Source) power supply) 115/230 V AC, 50/60 Hz Voltage supply available inside the device: <ul style="list-style-type: none"> – supplied voltage: 27 V DC regulated – maximum current: 125 mA – integrated protection: 125 mA time delay fuse
Current consumption	<p>With sensor, without consumption of digital input and pulse output</p> <ul style="list-style-type: none"> • With relays: <ul style="list-style-type: none"> – ≤100 mA (at 12 V DC) – ≤50 mA (at 36 V DC) – ≤55 mA (115/230 V AC) • Without relay: <ul style="list-style-type: none"> – ≤70 mA (at 12 V DC) – ≤35 mA (at 36 V DC) – ≤40 mA (115/230 V AC)
Power consumption	115/230 V AC powered measuring device: 3 VA
Inputs	<ul style="list-style-type: none"> • DI (1 to 4) • Switching threshold V_{on}: 5...36 V DC • Switching threshold V_{off} max.: 2 V DC • Min. pulse duration: 100 ms • Input impedance: 9.4 KOhms • Galvanic insulation, protected against polarity reversals and voltage spike
Outputs	<ul style="list-style-type: none"> • Transistors (DO1 and DO4): <ul style="list-style-type: none"> – NPN or PNP (wiring dependant), potential-free – function: pulse output (by default for DO1), batch state (by default for DO4), configurable and parametrisable – 0...300 Hz – 5...36 V DC, 100 mA max., voltage drop at 100 mA: 2.7 V DC – duty cycle (pulse duration/period): >0.45 – galvanic insulation, protected against overvoltage, polarity reversals and short-circuits • Relays (DO2 and DO3): <ul style="list-style-type: none"> – 2 relays (normally open), parametrisable (by default: DO2 always configured to control the valve, parametrized of 100 % of the batch quantity and DO3 configured as alarm) – non UL recognized device: 230 V AC/3 A or 40 V DC/3 A (resistive load) – UL recognized device: 30 V AC/42 V_{peak}/3 A or 60 V DC/1 A – max. cutting power of 750 VA (resistive load)
Voltage supply cable	<ul style="list-style-type: none"> • External diameter (cable): <ul style="list-style-type: none"> – 6...12 mm (1 cable per cable gland) or – 4 mm when using a multi-way seal (2 cables per cable gland) • Cross section of wires: 0.75 mm²

Process/Port connection & communication

Electrical connection Cable glands M20 x 1.5

Environment and installation

Ambient temperature

Operation and storage:

- Version 12...36 V DC: -10...+60 °C (+5...+140 °F)
- Version 115/230 V AC: -10...+50 °C (+5...+122 °F)

1.3. Flow transmitter (Universal/for “Low Power” flowmeters) or remote batch controller

General data

The following data are valid for the universal and for “Low Power” flowmeters transmitters as well as for the batch controller.

Product properties

Material

Please make sure the device materials are compatible with the fluid you are using.

Detailed information can be found in chapter [“4.1. Chemical Resistance Chart – Bürkert resistApp”](#) on page 18.

Non wetted parts

Housing	<ul style="list-style-type: none"> • PC (panel-mounted version) • ABS (wall-mounted version)
Cover	ABS (wall-mounted version)
Front panel foil	Polyester
Seal	NBR
Screws	Stainless steel
Cable clips	PA (panel-mounted version)
Cable glands	PA (wall-mounted version)
Dimensions	Detailed information can be found in chapter “4. Materials” on page 18.
Display	15 × 60 mm, 8-digit LCD, alphanumeric, 15 segments, 9 mm high

Electrical data

Power source (not supplied)	Limited power source according to UL/EN 60950-1 standards or limited energy circuit according to UL/EN 61010-1 §9.4
DC reverse polarity protection	Yes
Overvoltage protection	Yes
Voltage supply cable	<ul style="list-style-type: none"> • Cable with maximum operating temperature greater than 80 °C (90 °C for UL-Recognized version) • Max. 50 m length • Cross section of wires: 0.2...1.5 mm²

Process/Port connection & communication

Electrical connection	<ul style="list-style-type: none"> • Panel-mounted version: terminals • Wall-mounted version: terminals via gland M16 × 1.5
-----------------------	---

Approvals and certificates

Standards

Degree of protection ¹⁾ according to EN 60529	<ul style="list-style-type: none"> • Panel-mounted version: <ul style="list-style-type: none"> – Front side: IP65 installation completed and closed cabinet – Rear side: IP20 inside the closed cabinet • Wall-mounted version: <ul style="list-style-type: none"> – IP65 under the following conditions: device wired, cover screwed tight and cable plug or glands mounted and tightened or with blind plug if not used
--	--

Directives

CE directives	The applied standards, which verify conformity with the EU Directives, can be found on the EU Type Examination Certificate and/or the EU Declaration of conformity (if applicable).
Certification	UL-Recognized for US and Canada

Environment and installation

Ambient temperature	Operation and storage: -10...+60 °C (+14...+140 °F)
Relative air humidity	≤80 %, without condensation
Height above sea level	Max. 2000 m
Operating conditions	Continuous
Equipment mobility	Fixed
Application range	Indoor and outdoor (protect the device against electromagnetic interference, ultraviolet rays and, when installed outdoors, against the effects of climatic conditions)
Installation category	Category I according to UL/EN 61010-1
Pollution degree	Degree 2 according to UL/EN 61010-1

1.) Not evaluated by UL

Universal flow transmitter

Note:

If the device is mounted in a humid environment or outside, then the maximum voltage allowed is **35 V DC** instead of 36 V DC.

Product properties	
Compatibility	Bürkert flowmeter with frequency output (8020, 8030, 8030HT, 8041, 8031, SE30+S077, 8071, 8077) or other sensors with compatible electrical data.
Performance data	
4...20 mA output uncertainty	± 1 % of range
Electrical data	
Operating voltage (V+)	<ul style="list-style-type: none"> • Panel-mounted version: <ul style="list-style-type: none"> – 12...36 V DC, max tolerance: -5 % or + 10 % at 12 V DC, ± 10 % at 36 V DC, filtered and regulated Connection to main supply: permanent (through external SELV (Safety Extra Low Voltage) and LPS (Limited Power Source) power supply) • Wall-mounted version: <ul style="list-style-type: none"> – 12...36 V DC, max tolerance: -5 % or + 10 % at 12 V DC, ± 10 % at 36 V DC, filtered and regulated Connection to main supply: permanent (through external SELV (Safety Extra Low Voltage) and LPS (Limited Power Source) power supply) – 115/230 V AC, 50/60 Hz Voltage supply available inside the device: <ul style="list-style-type: none"> - supplied voltage: 27 V DC regulated - maximum current: 250 mA - integrated protection: 250 mA time delay fuse
Current consumption	<p>Without sensor and without consumption of 4...20 mA output of the flowmeter</p> <ul style="list-style-type: none"> • With relays: <ul style="list-style-type: none"> – ≤ 70 mA (at 12 V DC) – ≤ 45 mA (at 36 V DC) – ≤ 50 mA (115/230 V AC; wall-mounted version) • Without relay: <ul style="list-style-type: none"> – ≤ 50 mA (at 12 V DC) – ≤ 30 mA (at 36 V DC) – ≤ 35 mA (115/230 V AC, wall-mounted version)
Power consumption	115/230 V AC powered measuring device: 6 VA
Device input (from sensor)	<ul style="list-style-type: none"> • Frequency range: 0.6 Hz...2.2 kHz, can be adjusted • Voltage: max. 36 V DC • Type of the signal: <ul style="list-style-type: none"> – Pulse: open collector NPN (with 470 Ω or 2.2 kΩ resistance) or PNP, TTL, CMOS (with 39 kΩ resistance) – Sine-wave, coil (with 39 kΩ resistance – with minimum sensitivity of 50 mV peak to peak)
Device output (to sensor)	<ul style="list-style-type: none"> • Voltage supply with a powered 12...36 V DC transmitter: <ul style="list-style-type: none"> – 10.5...34.5 V DC [= (V+) - 1.5 V DC], 140 mA max. – 0...23.5 V DC [= (V+) - 12.5 V DC], 80 mA max. – 5 V DC, 30 mA max. • Voltage supply with a powered 115/230 V AC transmitter: <ul style="list-style-type: none"> – +27 V DC, 80 mA max. – +14.5 V DC [= (V+) - 12.5 V DC] 80 mA max. – 5 V DC, 30 mA max.

Outputs

- Transistor (digital output DO1):
 - Polarized, potential free, NPN or PNP (wiring dependant)
 - function: pulse output, adjustable pulse value
 - 0...2200 Hz, 5...36 V DC, 100 mA max.
 - Voltage drop at 100 mA: 2.7 V DC
 - duty cycle (pulse duration/period):
 - >0.45 if 0.6 < frequency < 300 Hz
 - >0.4 if 300 < frequency < 1500 Hz
 - <0.4 if 1500 < frequency < 2200 Hz
 - galvanic insulation, protected against overvoltage, polarity reversals and short-circuit
- Relays (digital outputs DO2 and DO3):
 - 2 relays, hysteresis, adjustable thresholds, normally open
 - non UL recognized device: 230 V AC/3 A or 40 V DC/3 A (resistive load)
 - UL recognized device: 30 V AC/42 V_{peak}/3 A or 60 V DC/1 A
 - max. cutting power of 750 VA (resistive load)
 - life span of min. 100000 cycles
- Current (analogue output AO1):
 - 4...20 mA (3-wire)
 - sourcing or sinking (wiring dependant)
 - 22 mA to indicate a fault (can be activated)
 - max. loop impedance: 1300 Ω at 36 V DC, 1000 Ω at 30 V DC, 750 Ω at 24 V DC, 300 Ω at 15 V DC, 200 Ω at 12 V DC, 900 Ω with a 115/230 V AC voltage supply

Voltage supply cable

Wall-mounted version
 External diameter (cable): 4...8 mm (for the cable glands)

Flow transmitter for “Low Power” flowmeters
Note:

If the device is mounted in a humid environment or outside, then the maximum voltage allowed is **35 V DC** instead of 36 V DC.

Product properties	
Compatibility	Bürkert flowmeter with frequency output (8020, 8030, SE30+S077) with pulse standard version.
Performance data	
4...20 mA output uncertainty	± 1 % of range
Electrical data	
Operating voltage (V+)	<ul style="list-style-type: none"> • Panel-mounted version: <ul style="list-style-type: none"> – 12...36 V DC ± 10 %, filtered and regulated Connection to main supply: permanent (through external SELV (Safety Extra Low Voltage) and LPS (Limited Power Source) power supply • Wall-mounted version: <ul style="list-style-type: none"> – 12...36 V DC ± 10 %, filtered and regulated Connection to main supply: permanent (through external SELV (Safety Extra Low Voltage) and LPS (Limited Power Source) power supply – 115/230 V AC, 50/60 Hz Voltage supply available inside the device: <ul style="list-style-type: none"> - supplied voltage: 27 V DC regulated - maximum current: 250 mA - integrated protection: 250 mA time delay fuse
Current consumption	With sensor and without pulse output consumption <ul style="list-style-type: none"> • With relays: ≤ 70 mA • Without relay: ≤ 25 mA
Power consumption	115/230 V AC powered measuring device: 6 VA
Device input (from sensor)	<ul style="list-style-type: none"> • Frequency range: 2.5...400 Hz • Pulse signal (Hall): “Low Power”, NPN Open Collector
Device output (to sensor)	Voltage supply 10...34 V DC [= (V+) - 2 V DC], 1 mA max.
Outputs	<ul style="list-style-type: none"> • Pulse (potential free transistor): <ul style="list-style-type: none"> – polarized, NPN or PNP (wiring dependant) – function: pulse output, adjustable pulse value – 0...400 Hz – 5...36 V DC, 100 mA, voltage drop at 100 mA: 2.5 V DC – duty cycle (pulse duration/period): 0.5 – galvanic insulation and protected against overvoltage, polarity reversals and short circuit • Relay: <ul style="list-style-type: none"> – 2 relays, hysteresis, adjustable thresholds, normally open – non UL recognized device: 230 V AC/3 A or 40 V DC/3 A (resistive load) – UL recognized device: 30 V AC/42 V_{peak}/3 A or 60 V DC/1 A • Current: <ul style="list-style-type: none"> – 4...20 mA (3-wire with relays; 2-wire without relay) – sourcing or sinking (wiring dependant) – max. loop impedance: 900 Ω at 30 V DC, 600 Ω at 24 V DC, 50 Ω at 12 V DC, 800 Ω with a 115/230 V AC voltage supply – response time (10...90 %) for the measured value: 6 s (default)
Voltage supply cable	Wall-mounted version External diameter (cable): 4...8 mm (for the cable glands)

Remote batch controller

Note:

If the device is mounted in a humid environment or outside, then the maximum voltage allowed is **35 V DC** instead of 36 V DC.

Product properties	
Compatibility	Bürkert flow sensor with frequency output (8020, 8030, 8030HT, 8041, 8031, 8070, 8071) or other sensors with compatible electrical data.
Operating voltage (V+)	<ul style="list-style-type: none"> 12...36 V DC, max tolerance: -5 % or +10 % at 12 V DC, ±10 % at 36 V DC, filtered and regulated Connection to main supply: permanent (through external SELV (Safety Extra Low Voltage) and LPS (Limited Power Source) power supply 115/230 V AC, 50/60 Hz Voltage supply available inside the device: <ul style="list-style-type: none"> – supplied voltage: 27 V DC regulated – maximum current: 250 mA – integrated protection: 250 mA time delay fuse
Current consumption	<p>With sensor and without consumption of 4...20 mA output of the flowmeter</p> <ul style="list-style-type: none"> With relays: <ul style="list-style-type: none"> – ≤70 mA (at 12 V DC) – ≤45 mA (at 36 V DC) – ≤50 mA (115/230 V AC; wall-mounted version) Without relay: <ul style="list-style-type: none"> – ≤50 mA (at 12 V DC) – ≤30 mA (at 36 V DC) – ≤35 mA (115/230 V AC; wall-mounted version)
Power consumption	115/230 V AC powered measuring device: 6 VA
Device input (from sensor)	<ul style="list-style-type: none"> Frequency range: 0.6 Hz...2.2 kHz Voltage: Max. 36 V DC Type of the signal: <ul style="list-style-type: none"> – Pulse: open collector NPN (with 470 Ω or 2.2 kΩ resistance) or PNP, TTL, CMOS (with 39 kΩ resistance) – Sine-wave: coil (with 39 kΩ resistance)
Device output (to sensor)	<ul style="list-style-type: none"> Voltage supply with a powered 12...36 V DC transmitter: <ul style="list-style-type: none"> – 10.5...34.5 V DC [= (V+) - 1.5 V DC], 140 mA max. – 0...23.5 V DC [= (V+) - 12.5 V DC], 80 mA max. – 5 V DC, 30 mA max. Voltage supply with a powered 115/230 V AC transmitter: <ul style="list-style-type: none"> – +27 V DC, 80 mA max. – +14.5 V DC [= (V+) - 12.5 V DC] 80 mA max. – 5 V DC, 30 mA max.
Inputs	<ul style="list-style-type: none"> DI (1 to 4) Switching threshold V_{on}: 5...36 V DC Switching threshold V_{off} max.: 2 V DC Min. pulse duration: 100 ms Input impedance: 9.4 KOhms Galvanic insulation, protected against polarity reversals and voltage spike

Outputs

- Transistors (DO1 and DO4):
 - NPN or PNP (wiring dependent), potential free
 - function: pulse output (by default for DO1), state (by default for DO4), configurable and parametrisable
 - 0...2200 Hz, 5...36 V DC, 100 mA max.
 - Voltage drop at 100 mA: 2.7 V DC
 - duty cycle (pulse duration/period):
 - >0.45 if 0.6 < frequency < 300 Hz
 - >0.4 if 300 < frequency < 1500 Hz
 - <0.4 if 1500 < frequency < 2200 Hz
 - Galvanic insulation, protected against overvoltage, polarity reversals and short-circuits
- Relays (DO2 and DO3):
 - 2 relays (normally open), parametrisable (by default: DO2 always configured to control the valve, parametrised of 100% of the batch quantity and DO3 configured as alarm)
 - non UL recognized device: 230 V AC/3 A or 40 V DC/3 A (resistive load)
 - UL recognized device: 30 V AC/42 V_{peak}/3 A or 60 V DC/1 A
 - max. cutting power of 750 VA (resistive load)

Voltage supply cable

Wall-mounted version
 External diameter (cable): 5...8 mm (for the cable glands)

2. Product versions

2.1. Insertion flowmeter

Note:

The compact version is available in two versions:

- Insertion flowmeter with standard output signal (4...20 mA, frequency)
- Insertion flowmeter as battery powered indicator/totalizer



Insertion flowmeter with standard output signal

The device makes it possible to switch a solenoid valve, activate an alarm or generate a flow rate proportional frequency, thanks to a digital output and, for some versions, by means of two relay outputs, fully configurable, and to establish a control loop thanks to a 4...20 mA current output.

The device is equipped with a 4...20 mA current output (analogue output), a digital output (pulse output) and two totalizers.

Some versions are also fitted with two relay outputs.

The device operates on a 2- or 3-wire system and needs a 12...36 V DC or a 115/230 V AC power supply.



Insertion flowmeter as battery powered indicator/totalizer

The device has no output and displays the instantaneous value as well the amount of liquid that has flowed through.

2.2. Insertion compact batch controller



When mounted in a pipe in series with one or two valves, the 8025 batch controller makes it possible to carry out a dosing of one or several quantities of liquids. The unit controls the opening of the valves and measures the quantity of the fluid which flows. The unit also closes the valves when the pre-set quantity has been delivered..

The electronic component needs a voltage supply of 12...36 V DC or 115/230 V AC.

The device is equipped

- 4 digital inputs (DI1 to DI4),
- two transistor outputs (DO1 configured as a pulse output and DO4 configured as state output, by default),
- two relay outputs (DO2 always configured to control the valve and by default parametrise of 100 % of the batch quantity and DO3 configured as alarm output by default),
- two volume or mass totalizers and two batch totalizers.

The second relay output can be used to activate another valve, to initiate alarms or to generate warnings.

2.3. Universal flow transmitter



The Universal transmitter is available in wall-mounted and panel versions.

The Universal transmitter can be associated with Bürkert flowmeter 8020, 8030, SE30+S077, ... (see chapter [“10.3. Combination of the remote version” on page 34](#) for more information) or another flow sensor which emits a frequency signal (with pulse output signal).

When connected to a flowmeter, the device makes it possible to switch a solenoid valve, activate an alarm or generate a flow rate proportional frequency, thanks to a digital output and, for some versions, by means of two relay outputs, fully configurable, and to establish a control loop thanks to a 4...20 mA current output.

The device is equipped with a 4...20 mA current output (analogue output, called AO1), a digital output (configured as a pulse output by default, called DO1) and two totalizers.

Some versions are also fitted with two relay outputs (called DO2 and DO3).

The device operates on a 3 wire system and needs a 12...36 V DC or a 115/230 V AC power supply.

2.4. Flow transmitter for “Low Power” flowmeters



The transmitter for “Low Power” flowmeters is available in wall-mounted and panel versions.

This transmitter version can **only be associated** with Bürkert flowmeter 8020, 8030, SE30+S077, ... (see chapter [“10.3. Combination of the remote version” on page 34](#) for more information) with sinus or pulse output signal in a “Low Power” version.

When connected to a flowmeter, the device makes it possible to switch a solenoid valve, activate an alarm or generate a flow rate proportional frequency, thanks to a digital output and, for some versions, by means of two relay outputs, fully configurable, and to establish a control loop thanks to a 4...20 mA current output.

The device is equipped with a 4...20 mA current output (analogue output), a digital output (pulse output) and two totalizers.

Some versions are also fitted with two relay outputs.

The device operates on a 2- or 3-wire system and needs a 12...36 V DC or a 115/230 V AC power supply..

2.5. Remote batch controller



The remote batch controller is available in wall-mounted and panel versions.

The batch controller can be associated with Bürkert flowmeters 8020, 8030, 8070... (see chapter [“10.3. Combination of the remote version” on page 34](#) for more information) or another flow sensor which emits a frequency signal (with pulse output signal).

When mounted in a pipe (compact version) or connected to a flowmeter (remote version) in series with one or two valves, the 8025 batch controller makes it possible to carry out a dosing of one or several quantities of liquids. The unit controls the opening of the valves and measures the quantity of the fluid which flows. The unit also closes the valves when the pre-set quantity has been delivered.

The electronic component needs a voltage supply of 12...36 V DC or 115/230 V AC.

The device is equipped with

- 4 digital inputs (DI1 up to DI4),
- 2 transistor outputs (DO1 configured as a pulse output and DO4 configured as state output, by default)
- 2 relay outputs (DO2 always configured to control the valve and by default parametrise of 100 % of the batch quantity and DO3 configured as alarm output by default)
- two volume or mass totalizers and two batch totalizers.

The second relay output can be used to activate another valve, to initiate alarms or to generate warnings.

3. Approvals

3.1. Certification UL

Certificate	Description
	UL-Recognized for USA and Canada Products are UL-certified products and comply also with the following standards: <ul style="list-style-type: none"> • UL 61010-1 • CAN/CSA-C22.2 No.61010-1

3.2. Pressure Equipment Directive

The device conforms to Article 4, Paragraph 1 of the Pressure Equipment Directive 2014/68/EU under the following conditions:

Device used on a pipe

Note:

- The data in the table is independent of the chemical compatibility of the material and the fluid.
- PS = maximum admissible pressure, DN = nominal diameter of the pipe

Type of fluid	Conditions
Fluid group 1, Article 4, Paragraph 1.c.i	DN ≤ 25
Fluid group 2, Article 4, Paragraph 1.c.i	DN ≤ 32 or PS*DN ≤ 1000
Fluid group 1, Article 4, Paragraph 1.c.ii	DN ≤ 25 or PS*DN ≤ 2000
Fluid group 2, Article 4, Paragraph 1.c.ii	DN ≤ 200 or PS ≤ 10 or PS*DN ≤ 5000

4. Materials

4.1. Chemical Resistance Chart – Bürkert resistApp

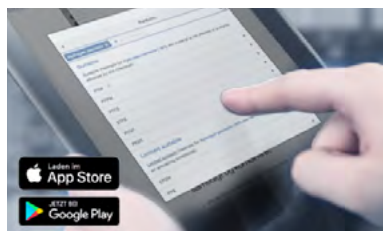

Bürkert resistApp – Chemical Resistance Chart

You want to ensure the reliability and durability of the materials in your individual application case? Verify your combination of media and materials on our website or in our resistApp.

[Start Chemical Resistance Check](#)

4.2. Material specifications

Insertion flowmeter or compact batch controller

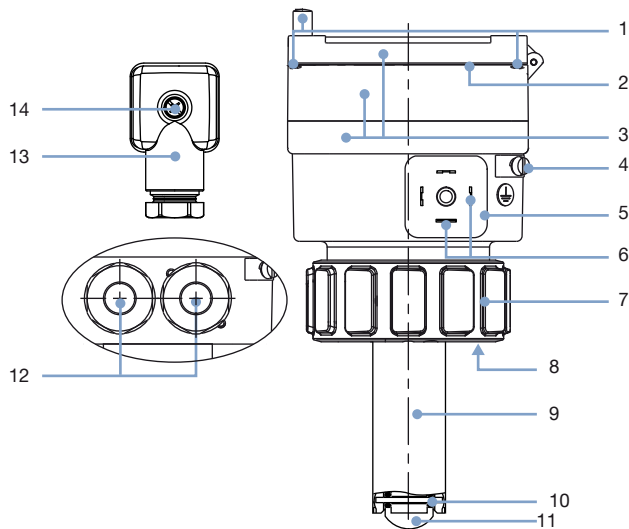

No.	Description	Material
1	Screws	Stainless steel
2	Front panel foil	Polyester
3	Housing, cover, lid	PC
4	Screw	Stainless steel
5	Male fixed plug (EN 175301-803)	PA
6	Electrical contact	Sn
7	Nut	PC
8	Seal	FKM (EPDM included, but not mounted)
9	Sensor holder	PVDF
10	Axis and bearings	Ceramics (Al ₂ O ₃)
11	Paddle wheel	PVDF
12	M20x1.5 cable gland	PA
13	Female cable plug (EN 175301-803)	<ul style="list-style-type: none"> • Body, contact holder and cable gland in PA • Cable gland seal and flat seal in NBR
14	Screw	Stainless steel

Flow transmitter (Universal/for “Low Power” flowmeters) or batch controller - panel version

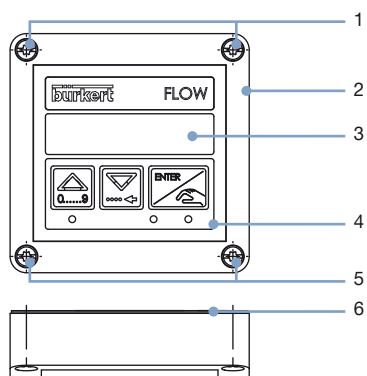

No.	Description	Material
1	Screws	Stainless steel
2	Housing	PC
3	Window	PPMA
4	Front panel foil	Polyester
5	Screws	Stainless steel
6	Seal	NBR
-	Cable clip (at the back of the housing)	PA

Flow transmitter (Universal/for “Low Power” flowmeters) or batch controller - wall-mounted version

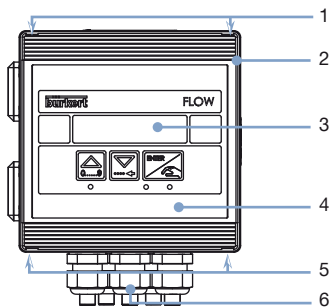

No.	Description	Material
1	Screws (under the cover plate)	Stainless steel
2	Housing and cover	ABS
3	Window	PPMA
4	Front panel foil	Polyester
5	Screws (under the cover plate)	Stainless steel
6	Cable glands	PA
-	Seal (between housing and cover)	NBR

5. Dimensions

5.1. Insertion flowmeter or compact batch controller

Note:

- Dimensions in mm
- The length of the flow probe depends on the used Insertion fitting Type S020 and its nominal diameter.

See [data sheet Type S020](#) ▶ for more information.

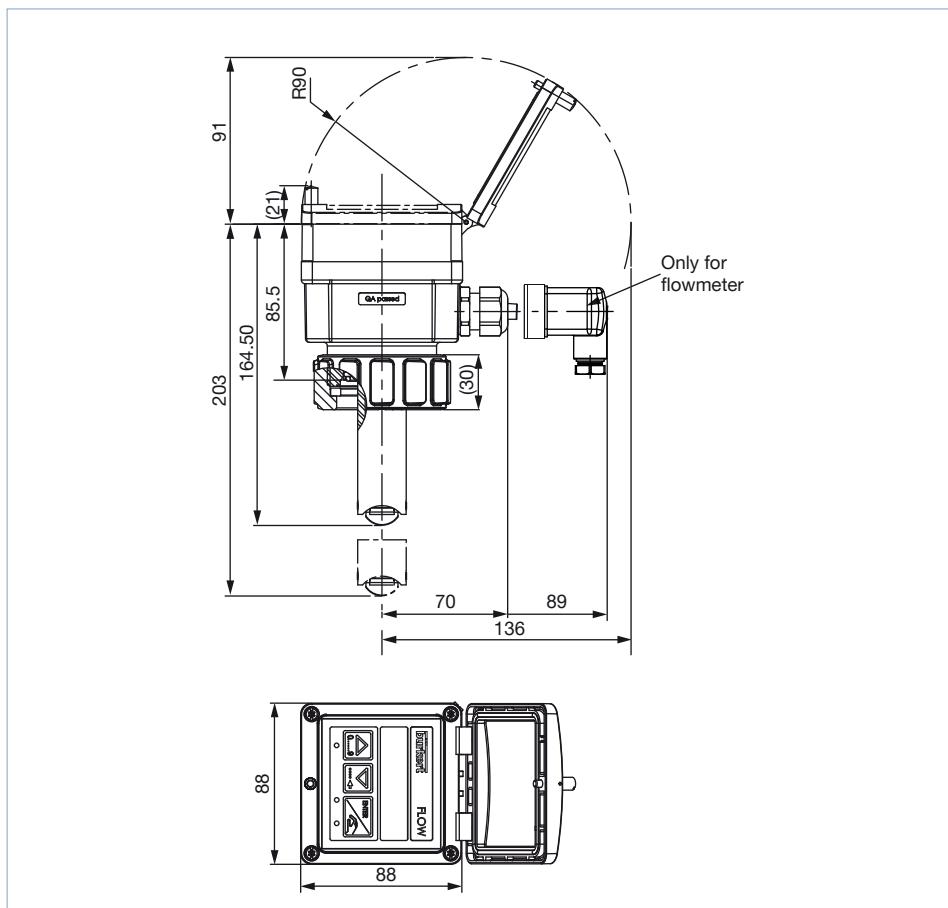

5.2. Device installed in a S020 fitting

Note:

Dimensions in mm

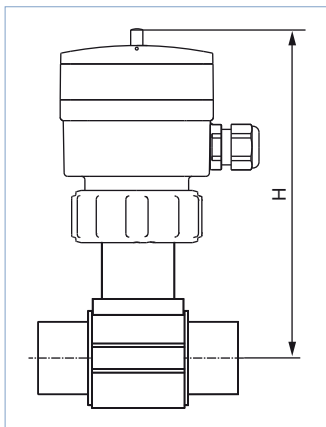

DN	H			
	T-Fitting	Saddle	Plastic spigot	Metal spigot
20	185	-	-	-
25	185	-	-	-
32	188	-	-	-
40	192	-	-	-
50	198	223	-	193
65	198	221	206	199
80	-	226	212	204
100	-	231	219	214
110	-	227	-	-
125	-	234	254	225
150	-	244	261	236
180	-	268	-	-
200	-	280	282	257
250	-	-	300	317
300	-	-	312	336
350	-	-	325	348
400	-	-	340	-

5.3. Flow transmitter or remote batch controller

Universal flow transmitter as panel version

Note:

Dimensions in mm

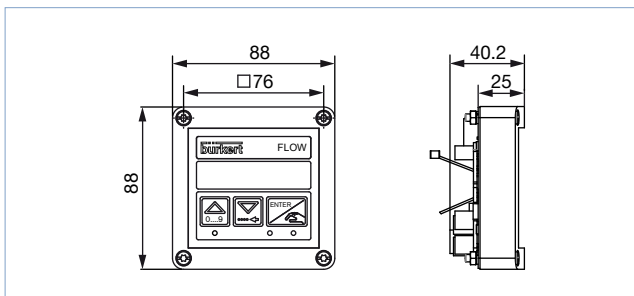

Universal flow transmitter as wall-mounted version

Note:

Dimensions in mm

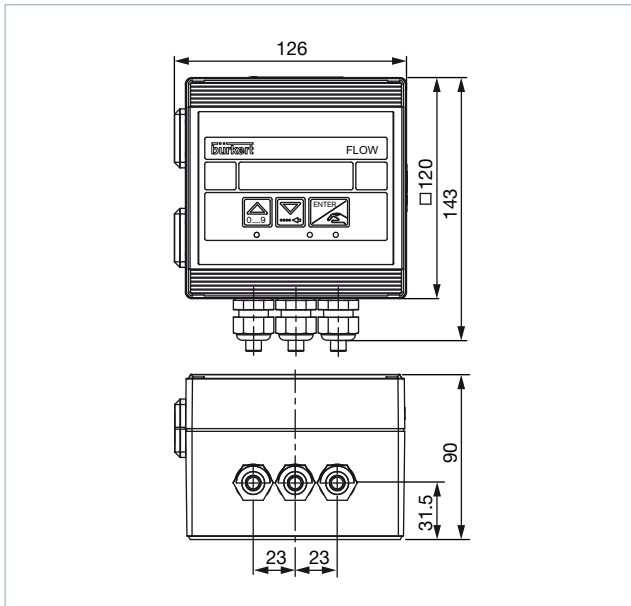

Flow transmitter for “Low Power” flowmeters as panel version

Note:

Dimensions in mm

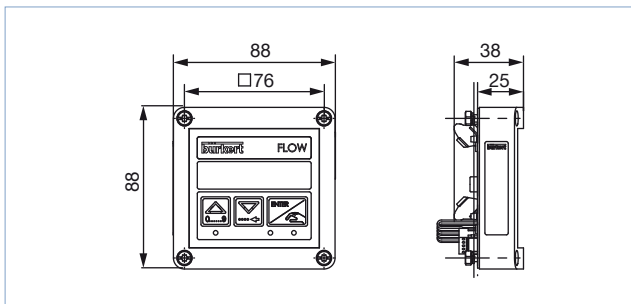

Flow transmitter for "Low Power" flowmeters as wall-mounted version

Note:

Dimensions in mm

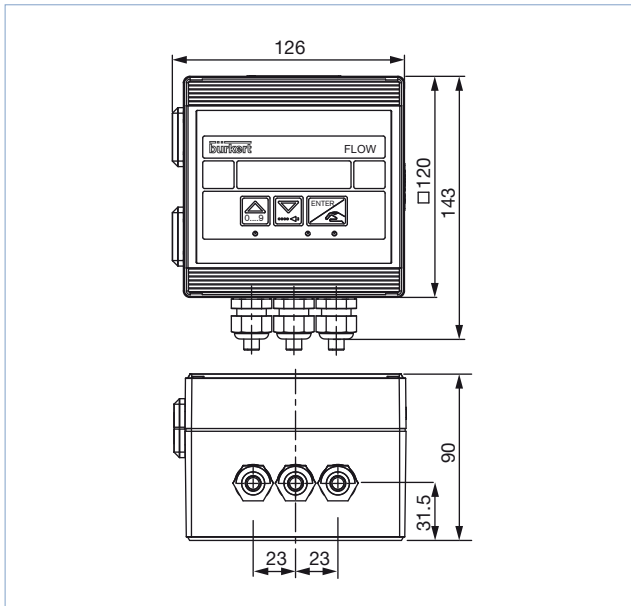

Batch controller as panel version

Note:

Dimensions in mm

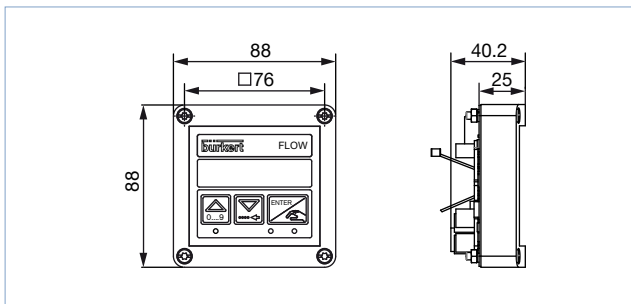

Batch controller as wall-mounted version

Note:

Dimensions in mm

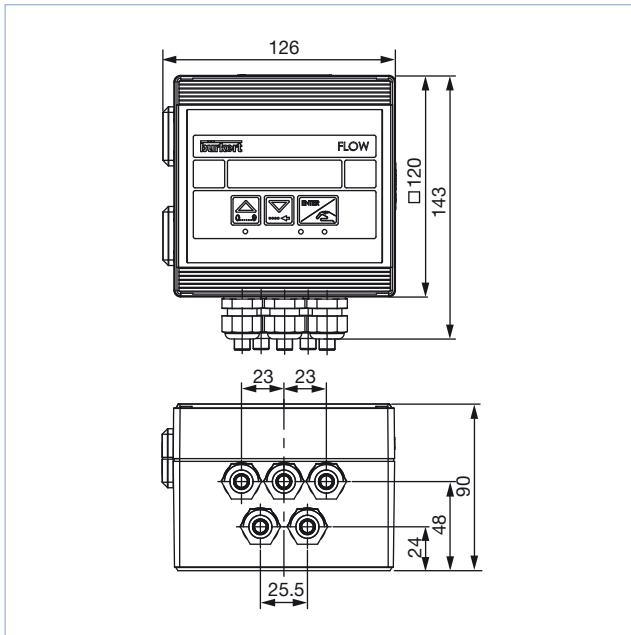

6. Performance specifications

6.1. Pressure temperature diagram

Note:

The following diagram applies only to the Insertion flowmeter or batch controller with paddle-wheel.

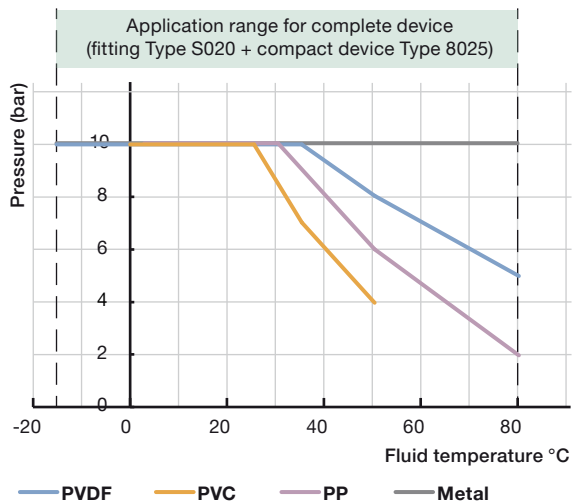

7. Product installation

7.1. Installation notes

Note:

- The following installation instructions only apply to the Insertion flowmeter or batch controller with paddle-wheel.
- The device is not designed for gas and steam flow measurement.

Minimum straight upstream and downstream distances must be observed. According to the pipe's design, necessary distances can be bigger or use a flow conditioner to obtain the best accuracy.

For more information, please refer to EN ISO 5167-1.

EN ISO 5167-1 specifies the straight inlet and outlet distances that must be complied with when installing fittings in pipe lines in order to achieve calm flow conditions. The most important layouts that could lead to turbulence in the flow are shown below, together with the associated specified minimum inlet and outlet distances.

Make sure that the measuring conditions at the point of measurement are calm and problem-free.

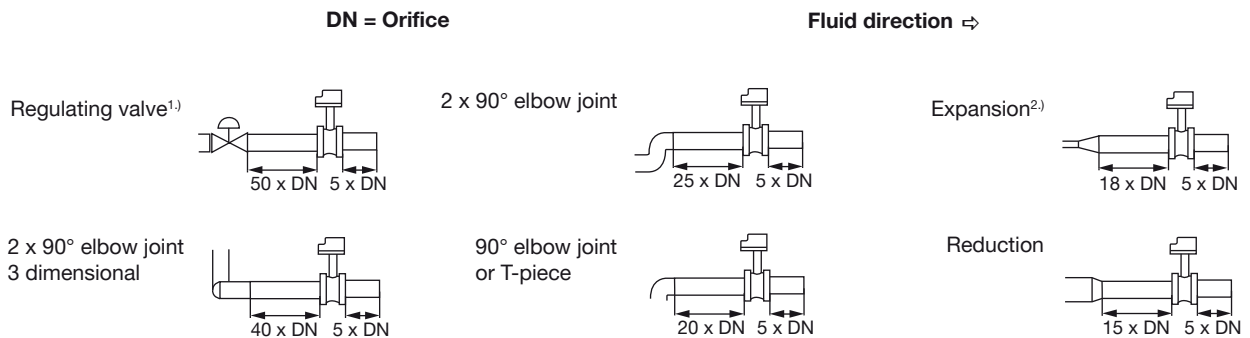

1.) If the valve cannot be mounted after the measuring device, the minimal distances have to be respected.
 2.) If an expansion cannot be avoided, the minimal distances have to be respected.
 Please note minimum flow velocity

The device can be installed into either horizontal or vertical pipes.

Important criteria for this are; ensure that the measurement pipe is fully filled and that the measurement pipe is free of bubbles.

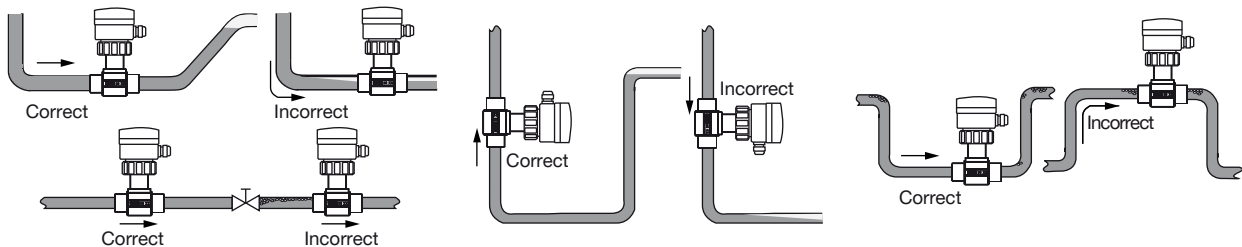

Pressure and temperature ratings must be respected according to the selected fitting material. The suitable pipe size is selected using the diagram for selecting the nominal diameter of the fitting, see **data sheet Type S020** ▶ for more information.

8. Product operation

8.1. Measuring principle

Note:

The following measuring principle only apply to the Insertion flowmeter or batch controller with paddle-wheel..

When liquid flows through the pipe, the paddle wheel with 4 inserted magnets is set in rotation, producing a measuring signal in the sensor (coil for battery indicator/totalizer version or Hall for other versions). The frequency modulated induced voltage is proportional to the flow velocity of the fluid.

A K-factor (available in the **instruction manual of the S020 fitting** ▶), specific to each pipe (size and material) enables the conversion of this frequency into a flow rate/volume.

Insertion flowmeter:

The electronic component converts the measured signal into several outputs (according to the flowmeter version) and displays the actual value. Totalizers are used to obtain the volume of fluid passed through the pipe.

The electrical connection for the flowmeter with standard output signal is provided via a cable plug according to EN 175301-803 or two cable glands (according to the flowmeter version).

Batch controller:

The electronic component converts the measured signal and displays the actual value of the volume or mass. The electrical connection is provided via two cable glands.

8.2. Functional overview

Display and operating keys

Note:

The following functional overview uses a picture of a panel-mounted version of the unit, but applies to all versions of Type 8025.

The display is used to:

- read the value of certain parameters e.g. for the flowmeter, the measured flow rate, the main totalizer
- set parameters of the device by means of 3 keys
- read the configuration of the device
- get notification of some events.

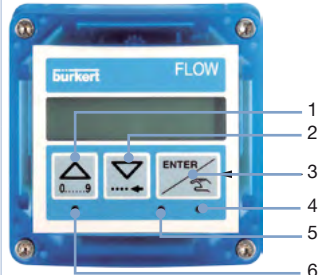
Display and operating keys	No.	Description
	1	<p>“Back” key:</p> <ul style="list-style-type: none"> to change the value (0...9) of the selected digit to go back to the previous function Read the batches history (only for batch controller)
	2	<p>“Next” key:</p> <ul style="list-style-type: none"> to select the digit at the left to go to the next function read messages (only with Insertion flowmeter as battery powered indicator/totalizer and with batch controller)
	3	<p>“Confirm” key:</p> <ul style="list-style-type: none"> to confirm the function displayed to confirm the parameters set
	4	<ul style="list-style-type: none"> For insertion flowmeter with a standard output signal and for transmitter for “Low Power” flowmeters <ul style="list-style-type: none"> status LED of relay 2 For Universal transmitter and batch controller <ul style="list-style-type: none"> status LED of relay DO3 (LED ON = contact closed)
	5	<ul style="list-style-type: none"> For insertion flowmeter with a standard output signal and for transmitter for “Low Power” flowmeters <ul style="list-style-type: none"> status LED of relay 1 For Universal transmitter and batch controller <ul style="list-style-type: none"> status LED of relay DO2 (LED ON = contact closed)
	6	<p>Status of device</p> <ul style="list-style-type: none"> No status for Insertion flowmeter with a standard output signal and for transmitter for “Low Power” flowmeters For Insertion flowmeter as a battery powered indicator/totalizer <ul style="list-style-type: none"> off: the device operates correctly. blinking orange: a warning message is generated in the information menu. blinking red: a fault message is generated For Universal transmitter <ul style="list-style-type: none"> green: the device operates correctly. orange: a warning messages is generated in the information menu. red: A fault message is generated and a 22 mA current is sent on the current output if activated. blinking, whatever the colour: a check for the correct behaviour of the outputs is running. The standard measurement function is inactive. For batch controller <ul style="list-style-type: none"> green: the device operates correctly. orange: a dosing related alarm and/or a warning messages is generated in the information menu. red: a fault message is generated in the information menu.. blinking, whatever the colour: <ul style="list-style-type: none"> slow blinking: the dosing is interrupted. Fast blinking during a dosing: a dosing related alarm is generated. Fast blinking when no dosing is being done: the information menu has been remote-consulted or a check for the correct behaviour of the inputs/outputs is running

The device can be calibrated by means of the K-factor of the fitting used, or via the Teach-In function. User adjustments, such as engineering units, output, filter, bargraph are carried out on site.

Flowmeter with a standard output signal and flow transmitter (Universal/for “Low Power” flowmeters)

The device has 2 operating levels:

- the process level
- the configuration level, which comprises the parameters and the test menus

Operating level	Functions
Process	<ul style="list-style-type: none"> • Indication of <ul style="list-style-type: none"> – the value of the measured flow – the value of the 4...20 mA output – the value of the main totalizer – the value of the daily totalizer • Reset the daily totalizer • Access to the Parameters and Test menus of the Configuration level
Configuration - parameters menu	<ul style="list-style-type: none"> • To make the settings needed for operation: <ul style="list-style-type: none"> – language – engineering units (International measuring units) – K-factor/Teach-In function – 4...20-mA-current output – pulse output – relay (on devices with relays) – filter (damping) – reset both totalizers – and only for Universal transmitter: <ul style="list-style-type: none"> - low flow “Cut Off“ - brightness of the display (backlight)
Configuration - test menu	<ul style="list-style-type: none"> • To adjust the Offset and Span of the 4...20 mA current output • To read the rotational frequency of the paddle wheel • To check the correct operating of the outputs with simulating a flow rate • and only for Universal transmitter: warning and fault messages generating

Insertion flowmeter as battery powered indicator/totalizer

The device has 2 operating levels:

- the process level
- the configuration level, which comprises the parameters, the test and the information menus

Operating level	Functions
Process	<ul style="list-style-type: none"> • Indication of <ul style="list-style-type: none"> – the value of the measured flow – the value of the main totalizer – the value of the daily totalizer • Reset the daily totalizer • Access to the Parameters, Test and Information menus of the Configuration level
Configuration - parameters menu	<ul style="list-style-type: none"> • To make the settings needed for operation: <ul style="list-style-type: none"> – language – engineering units (International measuring units) – K-factor/Teach-In function – filter (damping) – reset both totalizers
Configuration - test menu	<ul style="list-style-type: none"> • To read the rotational frequency of the paddle wheel • To generate warning and error messages
Configuration - information menu	<ul style="list-style-type: none"> • To read <ul style="list-style-type: none"> – the charge of the batteries – the error or warning messages generated by the device

Batch controller - compact and remote version

The device has 2 operating levels:

- The process level
- The configuration level, which includes the parameters, the test, the information and the history menus

Operating level	Functions
Process	<ul style="list-style-type: none"> • Starting a dosing • Indication of <ul style="list-style-type: none"> – The value of the main totalizers of the quantity of fluid counted – The value of the daily totalizers of the quantity of fluid counted – The value of the main totalizers of the performed dosings – The value of the daily totalizers of the performed dosings • Reset <ul style="list-style-type: none"> – The daily volume or mass totalizer – The daily totalizer of the performed dosings • Access to the parameters, test, information and history menus of the configuration level
Configuration - parameters menu	<ul style="list-style-type: none"> • To make the settings needed for operation: <ul style="list-style-type: none"> – language – engineering units (International measuring units) – K-factor/Teach-In function – Optional/dosing mode – Overfill – Alarm – Outputs – Resetting the 2 volume or mass totalizers – Resetting the 2 totalizers of the performed dosings – Resetting the history menu – Backlight
Configuration - test menu	<ul style="list-style-type: none"> • Checking: <ul style="list-style-type: none"> – The inputs functions – The outputs functions – The paddle-wheel operation • Monitoring: <ul style="list-style-type: none"> – The flow rate in the pipe – The value of the daily volume or mass totalizer – The number of performed dosings • Saving/ Restoring: <ul style="list-style-type: none"> – The current user configuration – The saved configuration – The default configuration of the device
Configuration - history menu	To consult the quantities dosed in the last 10 dosings performed
Configuration - information menu	To read the fault and warning messages generated

8.3. Function modes

Insertion flowmeter with a standard output signal

- 4...20 mA output + Pulse
- 4...20 mA output + Pulse + relay output
Hysteresis switching mode (both relays) for the output, inverted or not

Hysteresis mode

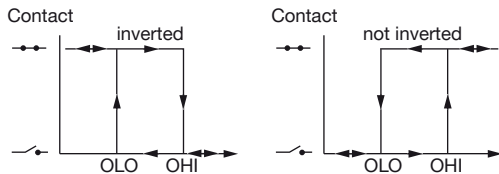

Batch controller - compact and remote versions

The following dosing modes are possible:

- **Locally started dosing of free quantity:** the user enters the quantity to be filled and starts the dosing from the keypad.
- **Locally started dosing of pre-set quantity:** the user selects a quantity which has been pre-set and starts the dosing from the keypad.
- **Locally started dosing of free/pre-set quantity:** the user enters the quantity to be filled or selects a quantity which has been pre-set and starts the dosing from the keypad.
- **Dosing controlled by a PLC unit:** the user selects a quantity which has been pre-set and starts the dosing using binary inputs.
- **Locally/remote selection of pre-set quantity and dosing controlled by a PLC unit:** the user selects a quantity which has been pre-set from the keypad or using binary inputs and starts the dosing using binary inputs.
- **Automatic dosing controlled by variation of pulse duration:** the quantity of the dosing is directly proportional to the duration of a pulse.
- **Remote dosing determined by Teach-In:** Teach-In of the dosing quantity using binary inputs.
- **Local dosing determined by Teach-In:** Teach-In of the dosing quantity from the keypads.

9. Product design and assembly

9.1. Product assembly

Insertion flowmeter or compact batch controller

Note:

- The 8025 flowmeter or batch controller can easily be installed into any Bürkert Insertion fitting system (S020) by just fixing the main nut.
- The S020 Insertion fitting ensures simple installation into pipes from DN 20...DN 400.

See **data sheet Type S020** ▶ for more information.

The device is equipped with a sensor with a paddle wheel, available in long or short version (dependent on the size of the used fitting). The sensor holder is plugged-in to the housing, which contains containing the electronic module with display and parameter keys.

The electrical connection is provided for the flowmeter via a cable plug or two cable glands (version with standard output signal) and for the batch controller via two cable glands.

Compact flowmeter or compact batch controller with a G 2" process connection



Insertion fitting Type S020



Complete device for flow measurement or dosing Type 8025



Fitting in stainless steel (only example)

Flow transmitter or remote batch controller

Note:

The separate 8025 device is available in a wall-mounted or panel version.

The panel version is made up of an electronics integrated in an open housing with display. The electrical connection is carried out on the terminal blocks of the electronic board.

The wall-mounted version is made up of an electronics integrated in a housing with cover and display. The electrical connection is carried out on the terminal blocks of the electronic board via 3 cable glands (for flow transmitter) or 5 (for batch controller).



10. Networking and combination with other Bürkert products

10.1. Networking and combination of the compact device

Insertion flowmeter with a standard output signal

Example:



4...20 mA output	Pulse output	Relay output	
<p>Type 8802 ▶ (2301 & 8693) ELEMENT Continuous control valve systems</p>	<p>Type 6212 ▶ Servo-assisted 2/2 way diaphragm valve</p>	<p>Type 6281 ▶ Servo-assisted 2/2 way diaphragm valve</p>	<p>Type S020 ▶ Insertion fitting for flow or analytical measurement</p>

Compact Insertion batch controller

Example:

Type 8025	<p>Type S020 ▶ Insertion fitting for flow or analytical measurement</p>	<p>Type 6212 ▶ Servo-assisted 2/2 way diaphragm valve</p>	<p>Type 6281 ▶ Servo-assisted 2/2 way diaphragm valve</p>

10.2. Combination of the compact device with available S020 fittings DN

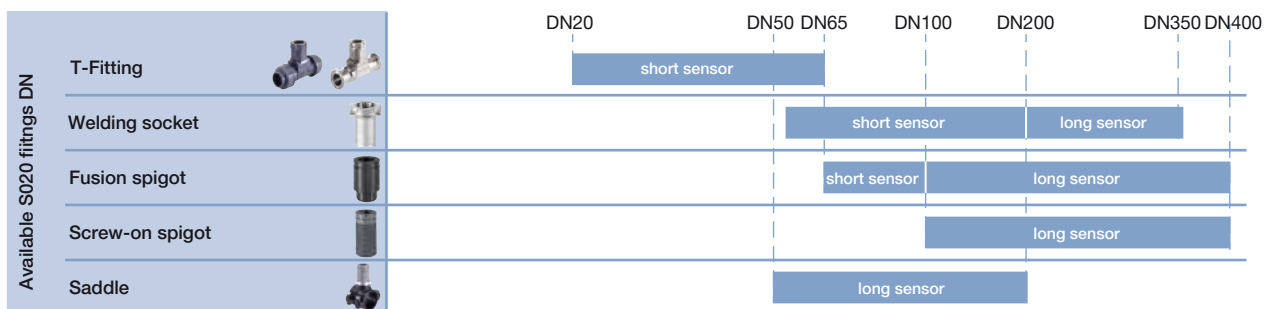

10.3. Combination of the remote version

Note:

Connection possibilities according to the flow meter version

		Universal transmitter		Transmitter for "Low Power" flowmeters		Batch controller	
		Panel	Wall-mounted	Panel	Wall-mounted	Panel	Wall-mounted
	Hall version (short or long) Frequency output with pulse signal (NPN, PNP, open collector)	Yes	Yes	No	No	Yes	Yes
	Hall „Low Power“ version (short or long) Frequency output with pulse signal (NPN, open collector)	Yes	Yes	Yes	Yes	Yes	Yes
Type 8020 ▶ Insertion flowmeter							
	Hall version Frequency output with pulse signal (NPN, PNP, open collector)	Yes	Yes	No	No	Yes	Yes
	Hall „Low Power“ version Frequency output with pulse signal (NPN, open collector)	Yes	Yes	Yes	Yes	Yes	Yes
Type 8030 (SE30 + S030) ▶ or Type SE30+S077 ▶ Inline flowmeter							
	Frequency output with pulse signal (NPN, PNP, open collector)	Yes	Yes	No	No	Yes	Yes
Type 8030 HT ▶ Inline flowmeter for high temperature							
		Yes	Yes	No	No	Yes	Yes
Type SE30 Ex + (S030 or S077) ▶ Inline flowmeter for hazardous areas							
	Frequency output with pulse signal (NPN)	Yes	Yes	No	No	Yes	Yes
Type 8031 ▶ Flow sensor for low-flow measurement							
	Frequency output with pulse signal (NPN)	Yes	Yes ^{1.)}	No	No	Yes	Yes ^{1.)}
Type 8041 ▶ Insertion magnetic inductive flowmeter							
	Frequency output with pulse signal (NPN)	Yes	Yes	No	No	Yes	Yes
Type 8071 ▶ or Type 8077 ▶ Flowmeter with oval rotors							

1.) Except device with article no. 419543

11. Ordering information

11.1. Bürkert eShop – Easy ordering and quick delivery



Bürkert eShop – Easy ordering and fast delivery

You want to find your desired Bürkert product or spare part quickly and order directly? Our online shop is available for you 24/7. Sign up and enjoy all the benefits.

[Order online now](#)

11.2. Recommendation regarding product selection

Insertion compact flowmeter or compact batch controller

A complete 8025 flowmeter or batch controller with integrated paddle wheel sensor consists of a compact 8025 flowmeter or batch controller and a Bürkert S020 Insertion fitting.

See [data sheet Type S020](#) ▶ for more information.

Two different components must be ordered in order to select a complete device. The following information is required:

- **Article no.** of the desired compact flowmeter or batch controller Type 8025 (see chapter [“Insertion flowmeter” on page 36](#) or [“Compact batch controller” on page 37](#))
- **Article no.** of the selected S020 Insertion sensor-fitting (see [data sheet Type S020](#) ▶)

Universal flow transmitter

A complete remote 8025 Universal transmitter (panel or wall-mounted), for connection to Bürkert or other sensors, consists of a remote 8025 Universal transmitter and a Bürkert flowmeter (or other compatible flowsensor on the market).

Two different components must be ordered in order to select a complete device. The following information is required:

- **Article no.** of the desired remote 8025 Universal transmitter (see chapter [“Universal transmitter” on page 37](#))
- **Article no.** of the selected Bürkert flowmeter (see chapter [“10.3. Combination of the remote version” on page 34](#) and also the corresponding data sheet)

Flow transmitter for “Low Power” flowmeters

This separate transmitter Type 8025 is only suitable for connection to Bürkert “Low Power” flowmeters.

A complete remote 8025 transmitter for “Low Power” flowmeters (panel or wall-mounted) consists of:

- a remote 8025 transmitter for “Low Power” flowmeters and either
- a Bürkert 8020 flowmeter “Low Power” version associated to an Insertion S020 fitting or
- a SE30 flow transmitter “Low Power” version associated to an Inline sensor-fitting. The Inline sensor-fitting can be either Type S030 (SE30+S030 = Type 8030) or Type S077.

Three different components must be ordered in order to select a complete device. The following information is required:

- **Article no.** of the desired remote 8025 transmitter for “Low Power” flowmeters (see chapter [“Flow transmitter for “Low Power” flowmeters” on page 38](#))
- **Article no.** of the selected Bürkert 8020 flowmeter or Inline SE30 transmitter (pulse “Low Power” version) (see chapter [“10.3. Combination of the remote version” on page 34](#) and also and also the corresponding data sheet)
- **Article no.** of the selected Bürkert S020 fitting (DN 20...DN 400) or Inline S030 sensor-fitting (DN 06...DN 65) or Inline S077 sensor-fitting (DN 15...DN 100) (see corresponding data sheet)

Remote batch controller

A complete remote 8025 batch controller (panel or wall-mounted) for connection to Bürkert or other flow sensors consists of a remote 8025 batch controller (wall-mounted or panel-mounted) and a Bürkert flowmeter (or other compatible flow sensors on the market). The flowmeters may need to be ordered separately.

Two different components must be ordered in order to select a complete device. The following information is required:

- **Article no.** of the desired remote 8025 batch controller (see chapter **“Remote batch controller”** on page 38)
- **Article no.** of the selected Bürkert flowmeter (see chapter **“10.3. Combination of the remote version”** on page 34 and also the corresponding data sheet) or others

11.3. Bürkert product filter



Bürkert product filter – Get quickly to the right product

You want to select products comfortably based on your technical requirements? Use the Bürkert product filter and find suitable articles for your application quickly and easily.

[Try out our product filter](#)

11.4. Ordering chart

Insertion flowmeter

Note:

FKM seal in standard; 1 set including a black EPDM seal for the sensor, a stopper for an M20 x 1.5 cable gland, a 2 x 6 mm multi-way seal and a mounting instruction sheet is supplied with each flowmeter.

Operating voltage	Output	Relays	Sensor version	UL certification	Electrical connection	Article no.
Flowmeter with a standard output signal, 2 totalizers						
12...36 V DC	4...20 mA (2-wire) + pulse	None	Hall, short	—	Female cable plug EN 175301-803	418762
				UL-Recognized	2 cable glands	570457
			—	2 cable glands	418802	
			UL-Recognized	2 cable glands	570465	
	Hall, long	—	Female cable plug EN 175301-803	418763		
		UL-Recognized	2 cable glands	570458		
		—	2 cable glands	418803		
		UL-Recognized	2 cable glands	570466		
4...20 mA (3-wire) + pulse	2	Hall, short	—		418778	
			UL-Recognized		570461	
		Hall, long	—		418779	
			UL-Recognized		570462	
115/230 V AC	4...20 mA (2-wire) + pulse	None	Hall, short	—		418423
			Hall, long			418424
	4...20 mA (3-wire) + pulse	2	Hall, short			418431
			Hall, long			418432
Flowmeter as battery powered indicator/totalizer, 2 totalizers						
4x1.5 V DC AA Batteries	None	None	Coil, short	—	None	418403
			Coil, long			418405

Further versions on request



Approval
 FDA, UL-Recognized for USA and Canada (UL 61010-1 + CAN/CSA-C22.2 No. 61010-1)

DTS 1000011079 EN Version: AC Status: RL (released | freigegeben | valide) printed: 25.02.2022







Compact batch controller

Note:

FKM seal in standard; 1 set including a black EPDM seal for the sensor, a stopper for an M20 × 1.5 cable gland, a 2 × 6 mm multi-way seal and a mounting instruction sheet is supplied with each batch controller.

All these versions have as minimum:

- 2 transistor outputs (DO1 and DO4)
- 2 relay outputs (DO2 and DO3)
- 4 digital inputs (DI1...DI4)
- 2 volume or mass totalizers
- 2 batch totalizers

Operating voltage	Sensor version	UL certification	Electrical connection	Article no.
12...36 V DC	Hall, short	—	2 cable glands	419520 
		UL-Recognized		564414 
	Hall, long	—		419522 
		UL-Recognized		570469 
115/230 V AC	Hall, short	—	419521 	
	Hall, long	—	419529 	









Universal transmitter

Note:

Sensor version: see chapter “10.3. Combination of the remote version” on page 34.









All these versions have as minimum:

- a 4...20 mA current output (AO1)
- a digital output (DO1)
- two totalizers

Operating voltage	Output	Relays	UL certification	Electrical connection	Article no.
Panel mounted					
12...36 V DC	4...20 mA (3-wire) + pulse	None	—	Terminal strip	419538 
		2			419537 
		None	UL-Recognized		564416 
		2			564417 
Wall-mounted					
12...36 V DC	4...20 mA (3-wire) + pulse	None	—	3 cable glands	419541 
115/230 V AC		2			419540 
		None	419544 		
		2	419543 		

Flow transmitter for “Low Power” flowmeters
Note:

Sensor version: Types 8020, 8030 (SE30+S030), SE30+S077 in “Low Power” version (see chapter “[10.3. Combination of the remote version](#)” on page 34).





Operating voltage	Output	Relays	UL certification	Electrical connection	Article no.
Panel mounted, 2 totalizers					
12...36 V DC	4...20 mA (2-wire) + pulse	None	—	Terminal strip	418992 
	4...20 mA (3-wire) + pulse	2			418994 
	4...20 mA (2-wire) + pulse	None	UL-Recognized		552725 
	4...20 mA (3-wire) + pulse	2			552726 
Wall-mounted, 2 totalizers					
12...36 V DC	4...20 mA (2-wire) + pulse	None	—	3 cable glands	418397 
	4...20 mA (3-wire) + pulse	2			418396 
115/230 V AC	4...20 mA (2-wire) + pulse	None	—		418400 
	4...20 mA (3-wire) + pulse	2			418399 

Remote batch controller
Note:

Sensor version: see chapter “[10.3. Combination of the remote version](#)” on page 34.









All these versions have as minimum:

- 2 transistor outputs (DO1 and DO4)
- 2 relay outputs (DO2 and DO3)
- 4 digital inputs (DI1...DI4)
- 2 volume or mass totalizers
- 2 batch totalizers





Operating voltage	UL certification	Electrical connection	Article no.
Panel mounted			
12...36 V DC	—	Terminal strip	419536 
	UL-Recognized		564415 
Wall-mounted			
12...36 V DC	—	5 cable glands	433740 
115/230 V AC	—		433741 

11.5. Ordering chart accessories

Accessories for compact device

Description	Article no.
For flowmeter or batch controller	
Set with 2 cable glands M20 × 1.5 + 2 neoprene flat seals for cable gland or plug + 2 screw plugs M20 × 1.5 + 2 multi-way seals 2 × 6 mm	449755 
Set with 2 reductions M20 × 1.5 /NPT ½" + 2 neoprene flat seals for cable gland or plug + 2 screw plugs M20 × 1.5	551782 
Set with 1 stopper for unused cable gland M20 × 1.5 + 1 multi-way seal 2 × 6 mm for cable gland + 1 black EPDM seal for the sensor + 1 mounting instruction sheet	551775 
Mounting ring (open) for S020 fitting	619205 
PC - nut for S020 fitting	619204 
Set with 1 green FKM and 1 black EPDM seal	552111 
For flowmeter	
Female cable plug EN 175301-803 with cable gland - see Type 2518 ▶	572264 
Female cable plug EN 175301-803 with NPT ½" reduction without cable gland - see Type 2509 ▶	162673 
For batch controller	
Set with 8 FLOW front panel foils	553191 

Accessories for remote device

Description	Article no.
For flowmeter or batch controller, panel version	
Mounting set (screws, washer, nuts, cable clips)	554807 
Seal	419350 
Set with 8 FLOW front panel foils	553191 
For flowmeter or batch controller, wall-mounted version	
Power supply board 115/230 V AC + mounting instruction sheet	555722 

Bürkert – Close to You

For up-to-date addresses
please visit us at
www.burkert.com

DTS 1000011079 EN Version: AC Status: RL (released | freigegeben | validé) printed: 25.02.2022

